

Section 7

Motors & Accessories

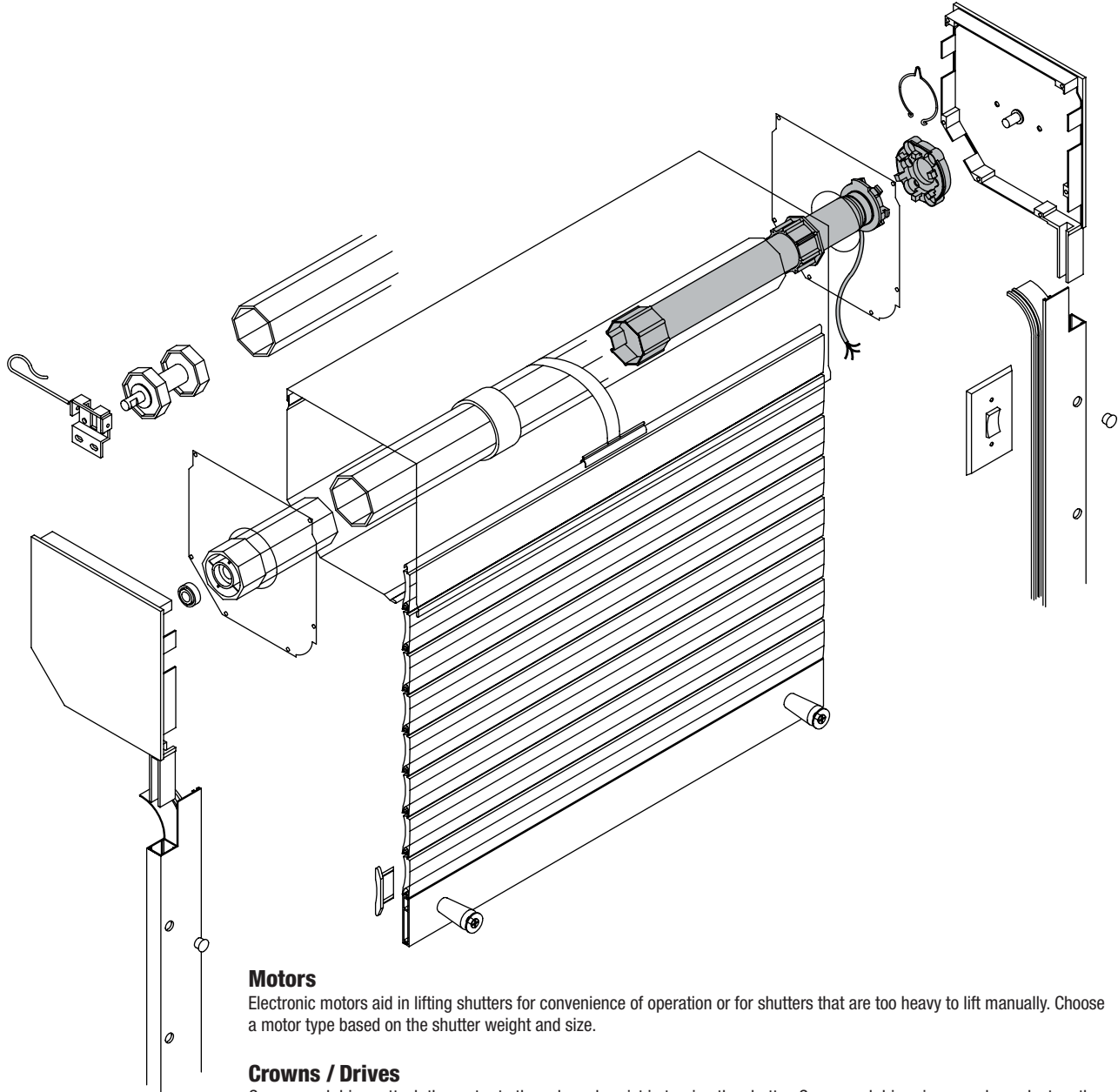

Motors

Electronic motors aid in lifting shutters for convenience of operation or for shutters that are too heavy to lift manually. Choose a motor type based on the shutter weight and size.

Crowns / Drives

Crowns and drives attach the motor to the axle and assist in turning the shutter. Crown and drive sizes are dependent on the size of the motor and axle.

Mounting Brackets

Mount the shutter to the building fascia.

SOMFY MOTORS

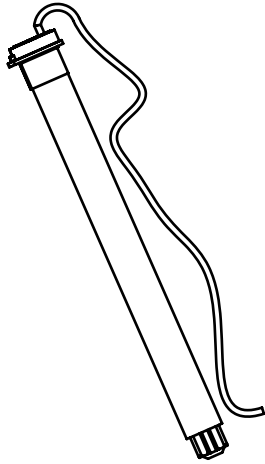

Somfy LT50 Motors

Part Number	Description	Unit	Note
8005-MOTO-00-ST	510R2 ELC*: 39 lbs / 60 mm Octagonal Tube, 40% SF.14 rpm	PC	
8008-MOTO-00-ST	515A2 ELC*: 58 lbs / 60 mm Octagonal Tube, 40% SF.20 rpm	PC	
8010-MOTO-00-ST	520R2 ELC*: 77 lbs / 60 mm Octagonal Tube, 40% SF.14 rpm	PC	
8015-MOTO-00-ST	525A2 ELC*: 97 lbs / 60 mm Octagonal Tube, 40% SF.20 rpm	PC	*
8020-MOTO-00-ST	530R2 ELC*: 117 lbs / 60 mm Octagonal Tube, 40% SF.14 rpm	PC	
8029-MOTO-00-ST	535A2 ELC*: 136 lbs / 60 mm Octagonal Tube, 40% SF.20 rpm	PC	
8034-MOTO-00-ST	540R2 ELC*: 156 lbs / 60 mm Octagonal Tube, 40% SF.14 rpm	PC	
8038-MOTO-00-ST	550R2 ELC*: 195 lbs / 60 mm Octagonal Tube, 40% SF.14 rpm	PC	

Somfy Altus 50 RTS - Radio Technology with Electronic Limit Switch

Part Number	Description	Unit	Note
8019-MOTO-00-ST	525A2 ALTUS RTS ELC*: 97 lbs / 60 mm Oct. Tube, 20 rpm	PC	*
8023-MOTO-00-ST	530R2 ALTUS RTS ELC*:117 lbs / 60 mm Oct. Tube, 14 rpm	PC	*
8024-MOTO-00-ST	535A2 ALTUS RTS ELC*:136 lbs / 60 mm Oct. Tube, 20 rpm	PC	
8022-MOTO-00-ST	540R2 ALTUS RTS ELC*:156 lbs / 60 mm Oct. Tube, 14 rpm	PC	
8039-MOTO-00-ST	550R2 ALTUS RTS ELC*:195 lbs / 60 mm Oct. Tube, 14 rpm	PC	

Somfy LT60 Motors

Part Number	Description	Unit	Note
8045-MOTO-LT-60	660R2 ELC*: 212 lbs / 70 mm Octagonal Tube, 40% SF.14 rpm	PC	
8047-MOTO-LT-60	680R2 ELC*: 280 lbs / 70 mm Octagonal Tube, 40% SF.14 rpm	PC	
8049-MOTO-LT-60	6100R2 ELC*: 352 lbs / 70 mm Octagonal Tube, 40% SF.14 rpm	PC	

Somfy Altus 60 RTS - Radio Technology with Electronic Limit Switch

Part Number	Description	Unit	Note
8013-MOTO-00-ST	660R2 ALTUS RTS ELC*: 212 lbs / 70 mm Oct. Tube, 14 rpm	PC	
8041-MOTO-00-ST	680R2 ALTUS RTS ELC*: 280 lbs / 70 mm Oct. Tube, 14 rpm	PC	
8044-MOTO-00-ST	6100R2 ALTUS RTS ELC*: 352 lbs / 70 mm Oct. Tube, 14 rpm	PC	

Somfy 500 Series Sunea RTS CMO Motors

Part Number	Description	Unit	Note
8106-MOTO-00-ST	525 A2 Sunea RTS CMO with 18" Fast Connector (Male)	PC	N
8108-MOTO-00-ST	535 A2 Sunea RTS CMO with 18" Fast Connector (Male)	PC	N
8112-MOTO-00-ST	550 A2 Sunea RTS CMO with 18" Fast Connector (Male)	PC	N

*Effective Lifting Capacity

- * - Typically ships within 3 days
- N - New item
- ! - Special order item

SOMFY MOTORS

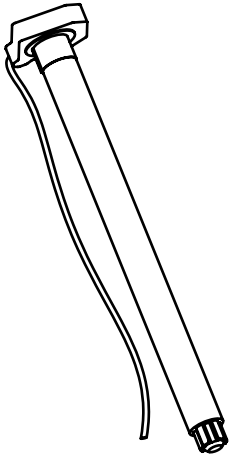

Somfy LT50 RTS CMO - Radio Technology (Manual Override)

Part Number	Description	Unit	Note
8016-MOTO-00-ST	525A2 RTS CMO ELC*: 97 lbs / 60 mm Oct. Tube, 20 rpm	PC	*
8028-MOTO-00-ST	530R2 RTS CMO ELC*: 117 lbs / 60 mm Oct. Tube, 14 rpm	PC	*
8026-MOTO-00-ST	535A2 RTS CMO ELC*: 136 lbs / 60 mm Oct. Tube, 20 rpm	PC	*
8031-MOTO-00-ST	540R2 RTS CMO ELC*: 156 lbs / 60 mm Oct. Tube, 14 rpm	PC	
8032-MOTO-00-ST	550R2 RTS CMO ELC*: 195 lbs / 60 mm Oct. Tube, 14 rpm	PC	

Somfy LT50 CMO Motors

Part Number	Description	Unit	Note
8017-MOTO-00-ST	525A2 CMO ELC*: 97 lbs / 60 mm Oct. Tube, 40% SF.20 rpm	PC	*
8025-MOTO-00-ST	530R2 CMO ELC*: 117 lbs / 60 mm Oct. Tube, 40% SF.14 rpm	PC	
8030-MOTO-00-ST	535A2 CMO ELC*: 136 lbs / 60 mm Oct. Tube, 40% SF.20 rpm	PC	
8036-MOTO-00-ST	540R2 CMO ELC*: 156 lbs / 60 mm Oct. Tube, 40% SF.14 rpm	PC	
8040-MOTO-00-ST	550R2 CMO ELC*: 195 lbs / 60 mm Oct. Tube, 40% SF.14 rpm	PC	*

Somfy LT60 CMO Motors

Part Number	Description	Unit	Note
8046-MOTO-LT-60	660R2 CMO ELC*: 212 lbs / 70 mm Oct. Tube, 14 rpm	PC	
8048-MOTO-LT-60	680R2 CMO ELC*: 280 lbs / 70 mm Oct. Tube, 14 rpm	PC	
8050-MOTO-LT-60	6100R2 CMO ELC*: 352 lbs / 70 mm Oct. Tube, 14 rpm	PC	

Somfy LS40 Tubular Electric Motors

Part Number	Description	Unit	Note
8011-MOTO-00-ST	409R2 ELC*: 59 lbs / 40 mm Round or 40 mm Oct / 16 rpm	PC	
8003-MOTO-00-ST	412R2 ELC*: 79 lbs / 40 mm Round or 40 mm Oct / 8 rpm	PC	
8001-MOTO-00-ST	409R2 Altus RTS ELC*: 59 lbs / 40 mm Round or 40 mm Oct / 16 rpm	PC	

* - Typically ships within 3 days
 N - New item
 ! - Special order item

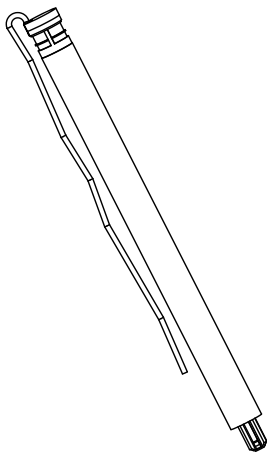

SIMU MOTORS - REGULAR

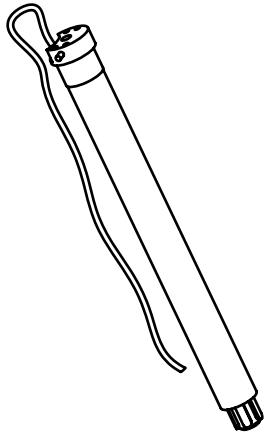

Simu Type 5 Standard Motors

Part Number	Description	Unit	Note
8063-MOTO-00-ST	510/12 ELC*: 38 lbs / 60 mm Octagonal Tube, 40% SF.12 rpm	PC	!
8064-MOTO-00-ST	515/18 ELC*: 58 lbs / 60 mm Octagonal Tube, 40% SF.18 rpm	PC	!
8070-MOTO-00-ST	520/12 ELC*: 77 lbs / 60 mm Octagonal Tube, 40% SF.12 rpm	PC	!
8066-MOTO-00-ST	525/18 ELC*: 97 lbs / 60 mm Octagonal Tube, 40% SF.18 rpm	PC	!
8080-MOTO-00-ST	530/12 ELC*: 117 lbs / 60 mm Octagonal Tube, 40% SF.12 rpm	PC	!
8090-MOTO-00-ST	535/18 ELC*: 136 lbs / 60 mm Octagonal Tube, 40% SF.18 rpm	PC	!
8095-MOTO-00-ST	540/12 ELC*: 155 lbs / 60 mm Octagonal Tube, 40% SF.12 rpm	PC	!
8099-MOTO-00-ST	550/12 ELC*: 194 lbs / 60 mm Octagonal Tube, 40% SF.12 rpm	PC	!

Simu - Type 5 Radio Hz - 02 Plus Operators

Part Number	Description	Unit	Note
8077-MOTO-00-ST	505/35 HZ ELC*: 20 lbs / 60 mm Oct. Tube, 40% SF.35 rpm	PC	!
8078-MOTO-00-ST	510/35 HZ ELC*: 38 lbs / 60 mm Oct. Tube, 40% SF.35 rpm	PC	!
8072-MOTO-00-ST	515/18 HZ ELC*: 58 lbs / 60 mm Oct. Tube, 40% SF.18 rpm	PC	!
8073-MOTO-00-ST	525/18 HZ ELC*: 97 lbs / 60 mm Oct. Tube, 40% SF.18 rpm	PC	!
8074-MOTO-00-ST	530/12 HZ ELC*: 117 lbs / 60 mm Oct. Tube, 40% SF.12 rpm	PC	!
8075-MOTO-00-ST	535/18 HZ ELC*: 136 lbs / 60 mm Oct. Tube, 40% SF.18 rpm	PC	!
8076-MOTO-00-ST	550/12 HZ ELC*: 194 lbs / 60 mm Oct. Tube, 40% SF.12 rpm	PC	!
8089-MOTO-00-ST	520/12 HZ ELC*: 77 lbs / 60 mm Oct. Tube, 40% SF.12 rpm	PC	N!

Simu Type 6 Standard Motors

Part Number	Description	Unit	Note
8111-MOTO-00-ST	660/14 ELC*: 212 lbs / 70 mm Oct. Tube, 40% SF.14 rpm	PC	!
8113-MOTO-00-ST	680/14 ELC*: 281 lbs / 70 mm Oct. Tube, 40% SF.14 rpm	PC	!
8118-MOTO-00-ST	6100/14 ELC*: 352 lbs / 70 mm Oct. Tube, 40% SF.14 rpm	PC	!

Simu Type 6 Radio Hz - 02 Plus Operators

Part Number	Description	Unit	Note
8145-MOTO-00-ST	660/14 HZ ELC*: 212 lbs / 70 mm Oct. Tube, 40% SF. 14 rpm	PC	!
8146-MOTO-00-ST	680/14 HZ ELC*: 281 lbs / 70 mm Oct. Tube, 40% SF. 35 rpm	PC	!
8147-MOTO-00-ST	6100/14 HZ ELC*: 352 lbs / 70 mm Oct. Tube, 40% SF. 18 rpm	PC	!

Simu Type 5 DC Operators (Low Voltage Motors: 12 V and 24 V)

Part Number	Description	Unit	Note
8079-MOTO-00-ST	Type 5 DC Operator T5 15 Nm 15 rpm 12 V	PC	!
8107-MOTO-00-ST	Type 5 DC Operator T5 35 Nm 7 rpm 12 V	PC	!
8112-MOTO-00-ST	Type 5 DC Operator T5 15 Nm 15 rpm 24 V	PC	!

Simu Type 3.5 DCE Hz Operator AUTOSUN

Part Number	Description	Unit	Note
8092-MOTO-00-ST	AUTOSUN 10Nm 12 rpm 12 V + Battery + Solar Panel	PC	!

* - Typically ships within 3 days
 N - New item
 ! - Special order item

SIMU MOTORS - DMI

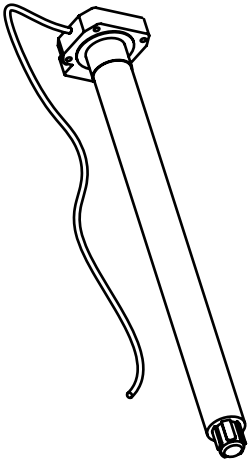

Simu Tubular Type 5 Override Operators

Part Number	Description	Unit	Note
8061-MOTO-00-ST	510 DMI ELC*: 38 lbs / 60 mm Oct. Tube, 40% SF.12 rpm	PC	!
8065-MOTO-00-ST	515 DMI ELC*: 58 lbs / 60 mm Oct. Tube, 40% SF.18 rpm	PC	!
8071-MOTO-00-ST	520 DMI ELC*: 77 lbs / 60 mm Oct. Tube, 40% SF.12 rpm	PC	!
8067-MOTO-00-ST	525 DMI ELC*: 97 lbs / 60 mm Oct. Tube, 40% SF.18 rpm	PC	!
8081-MOTO-00-ST	530 DMI ELC*: 117 lbs / 60 mm Oct. Tube, 40% SF.12 rpm	PC	!
8091-MOTO-00-ST	535 DMI ELC*: 136 lbs / 60 mm Oct. Tube, 40% SF.18 rpm	PC	!
8096-MOTO-00-ST	540 DMI ELC*: 155 lbs / 60 mm Oct. Tube, 40% SF.12 rpm	PC	!
8100-MOTO-00-ST	550 DMI ELC*: 194 lbs / 60 mm Oct. Tube, 40% SF.12 rpm	PC	!

Simu Type 5 Radio Hz Override Operators

Part Number	Description	Unit	Note
8082-MOTO-00-ST	515 DMI HZ ELC*: 58 lbs / 60 mm Oct. Tube, 40% SF.18 rpm	PC	!
8087-MOTO-00-ST	525 DMI HZ ELC*: 97 lbs / 60 mm Oct. Tube, 40% SF.18 rpm	PC	!
8083-MOTO-00-ST	530 DMI HZ ELC*: 117 lbs / 60 mm Oct. Tube, 40% SF.12 rpm	PC	!
8084-MOTO-00-ST	535 DMI HZ ELC*: 136 lbs / 60 mm Oct. Tube, 40% SF.18 rpm	PC	!
8085-MOTO-00-ST	550 DMI HZ ELC*: 194 lbs / 60 mm Oct. Tube, 40% SF.12 rpm	PC	!

Simu Type 6 Override Operators

Part Number	Description	Unit	Note
8101-MOTO-00-ST	660 DMI ELC*: 212 lbs / 70 mm Oct. Tube, 40% SF.14 rpm	PC	!
8116-MOTO-00-ST	680 DMI ELC*: 281 lbs / 70 mm Oct. Tube, 40% SF.14 rpm	PC	!
8119-MOTO-00-ST	6100 DMI ELC*: 352 lbs / 70 mm Oct. Tube, 40% SF.14 rpm	PC	!

Simu Type 6 Radio Hz Override Operators

Part Number	Description	Unit	Note
8148-MOTO-00-ST	660DMI HZ ELC*: 212 lbs / 70 mm Oct. Tube, 40% SF.14 rpm	PC	
8149-MOTO-00-ST	680DMI HZ ELC*: 281 lbs / 70 mm Oct. Tube, 40% SF.14 rpm	PC	
8150-MOTO-00-ST	6100DMI HZ ELC*: 352 lbs / 70 mm Oct. Tube, 40% SF.14 rpm	PC	

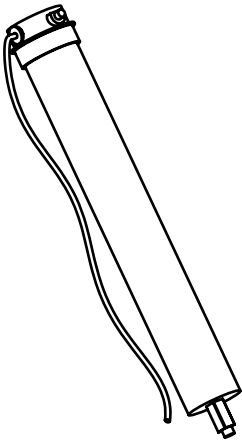

T8 - Heavy Duty Tubular Motor

Part Number	Description	Unit	Note
8069-MOTO-00-ST	Standard T8 Operator, 200Nm, 120 V, 10 rpm, 94 mm ID	PC	!
8068-MOTO-00-ST	DMI T8 Operator, 200Nm, 120 V, 10 rpm, 94 mm ID	PC	!
8097-MOTO-00-ST	T8 200 Tubular 200 Nm, 10 rpm, 94 mm ID	PC	N !
8098-MOTO-00-ST	T8 DMI Tubular 200 Nm, 10 rpm, 94 mm ID	PC	N !

* - Typically ships within 3 days
 N - New item
 ! - Special order item

ROLLAC MOTORS

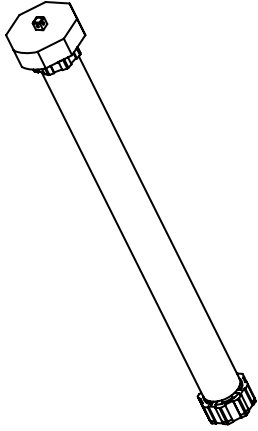

Rollac Tubular Electric 50 NM Series Motors (Crown, Drive Included)

Part Number	Description	Unit	Note
8161-MOTO-00-ST	550 Manual Override ELC 195 lbs / 60 mm / 14% / rpm 13	PC	*
8164-MOTO-00-ST	550 Radio Override ELC 195 lbs / 60 mm / 14% / rpm 13 w/Remote	PC	*

Rollac Tubular Electric 100 NM Series Motors (Crown, Drive, and Included)

Part Number	Description	Unit	Note
8166-MOTO-00-ST	6100 Manual Override ELC 352 lbs / 70mm / 14% / rpm 12	PC	*
8168-MOTO-00-ST	6100 Radio Override ELC 352 lbs / 70 mm / 14% / rpm 12 w/Remote	PC	*

* - Typically ships within 3 days
N - New item
! - Special order item

SOMFY / SIMU CROWNS & DRIVES

Somfy and Simu Crowns and Drives - 2.375"

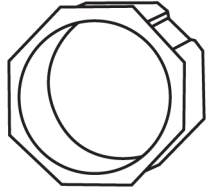
	Part Number	Description	Unit	Note
	8223-ADAP-00-XX	CROWN - For LT50/500 Series 60 mm Octagonal Tube	PC	*
	8224-ADAP-00-XX (8223 SHOWN)	DRIVE - For LT50/500 Series 60 mm Octagonal Tube	PC	*

Somfy and Simu Crowns - 2.75"

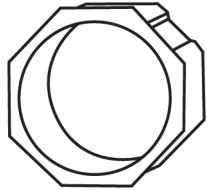
	Part Number	Description	Unit	Note
	8228-ADAP-00-XX	CROWN - For LT50/500 Series 70 mm Octagonal Tube	PC	
	8233-ADAP-LT-60 (8233 SHOWN)	CROWN - For LT60/600 Series 70 mm Octagonal Tube	PC	

Somfy and Simu Crowns and Drives - 2.5"

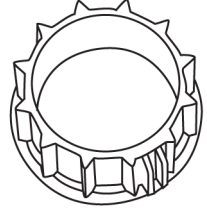
	Part Number	Description	Unit	Note
	8204-ADAP-00-XX	CROWN - FOR LT50/500 Series 63 mm Round Tube	PC	
	8205-ADAP-00-XX (8204 SHOWN)	DRIVE - FOR LT50/60 500/600 63 mm Round Tube	PC	

Somfy and Simu Crowns and Drives - 2.75"

	Part Number	Description	Unit	Note
	8208-ADAP-00-XX	CROWN - FOR LT50/500 Series 70 mm Round Tube	PC	
	8209-ADAP-00-XX	DRIVE - FOR LT50/60 500/600 70 mm Round Tube	PC	
	8210-ADAP-00-XX	CROWN - FOR LT60/600 Series 70 mm Round Tube	PC	
	8216-ADAP-00-XX (8216 SHOWN)	DRIVE - DS78/R FOR LT60/ 600 78 mm Round Awning Tube	PC	

Somfy Crowns & Drives for 400 Series Motors

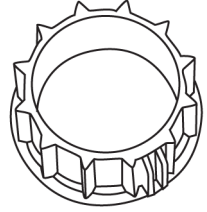
	Part Number	Description	Unit	Note
	8240-ADAP-00-XX	Crown for 40 mm Octagonal Tube	PC	
	8241-ADAP-00-XX	Drive for 40 mm Octagonal Tube	PC	
	8242-ADAP-00-XX	Crown for 40 mm Round Tube	PC	
	8243-ADAP-00-XX (8240 SHOWN)	Drive for 40 mm Round Tube	PC	

* - Typically ships within 3 days
N - New item
! - Special order item

SOMFY / SIMU CROWNS & DRIVES

Somfy and Simu Drives - 2.75"

	Part Number	Description	Unit	Note
	8234-ADAP-LT-60	DRIVE - For LT50/60 500/600 70 mm Octagonal Tube	PC	*
	8235-ADAP-LT-AL (8235 SHOWN)	DRIVE - For LT50/60 500/600 70 mm Oct. Tube (ALUM)	PC	*

Somfy and Simu Crowns and Drives - 3.5"

	Part Number	Description	Unit	Note
	8246-ADAP-00-XX	DRIVE - For LT50/60 500/600 89 mm Round Tube	PC	

Somfy and Simu Crowns and Drives - 4.0"

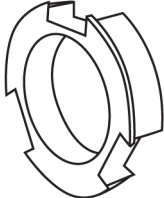
	Part Number	Description	Unit	Note
	8249-ADAP-00-XX	CROWN - For LT60/ 600 Series 100 mm Round Tube	PC	
	8250-ADAP-00-XX (8249 SHOWN)	DRIVE - For LT60/ 600 Series 100 mm Round Tube	PC	

Selve Crown and Drive Kit - 2.0 For 50 mm Octagonal Selve Tube

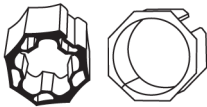
	Part Number	Description	Unit	Note
	8264-ADAP-00-XX	For LT50/ 500 Series Motor	PC	

* - Typically ships within 3 days
 N - New item
 ! - Special order item

CROWNS & DRIVES

Somfy and Simu Crowns and Drives - DS 78

	Part Number	Description	Unit	Note
	8198-ADAP-00-XX	CROWN - FOR LT50/500 Series 78 mm Round Awning Tube	PC	
	8215-ADAP-00-XX	CROWN - FOR LT60/600 Series 78 mm Round Awning Tube	PC	
	8199-ADAP-00-XX (8199 SHOWN)	DRIVE - FOR LT50/60 500/600 78 mm Round Awning Tube	PC	

Somfy and Simu Crowns and Drives - P 72

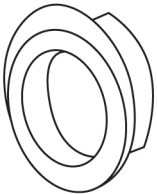
	Part Number	Description	Unit	Note
	8197-ADAP-00-XX (8200 SHOWN)	CROWN - FOR LT60/600 Series 72 mm Round Awning Tube	PC	

Somfy and Simu Drive - 2.0"

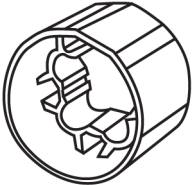
	Part Number	Description	Unit	Note
	8195-ADAP-00-XX	DRIVE - FOR LT50/500 Series (Soft Clip) 50 mm Round Tube	PC	

Rollac Crowns, Drives, and Bracket

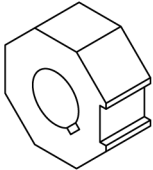
	Part Number	Description	Unit	Note
	8175-ADAP-00-PL	Plastic Crown Cap f/D-Motor to enlarge from 60 mm to 70 mm	PC	
	8176-ADAP-00-PL	Plastic Drive Adaptor f/series 45 and 59 to 70 mm Axle	PC	
	8177-BRCK-00-ST	10mm Bracket f/Reg Motors	PC	
	8178-ADAP-00-AL (8178 SHOWN)	Aluminum Drive Adaptor f/70 mm Oct for D-Motor	PC	

* - Typically ships within 3 days
 N - New item
 ! - Special order item

MOTOR BRACKETS

Somfy Motor Brackets for Standard and Standard RTS

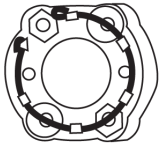
	Part Number	Description	Unit	Note
	8311-BRCK-LT-60	Universal Motor Bracket With Spring Ring LT50 LT60	PC	*
	8316-BRCK-00-ST	For BK-45 250S (10") & 300S (12") Side Cap 4" x 4"	PC	
	8326-BRCK-00-ST	"HA" Plate With Motor Bracket For LT50 And LT60	PC	
	8330-BRCK-00-ST (8311 SHOWN)	Spring Ring Used With All Brackets For LT50 & LT60	PC	

T8 Drive, Bracket, Idler

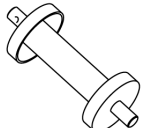
	Part Number	Description	Unit	Note
	8279-ADAP-00-XX	T8 94 mm Round Drive	PC	
	8370-BRCK-00-ST	T8 Bracket Angle 2 Pc Set	PC	
	8259-SWIT-00-XX	94 mm Idler Insert	PC	
	8202-ADAP-00-XX (8259 SHOWN)	T8 97mm Adapter Set	PC	N

Operator Bracket Type DMI Override for Simu

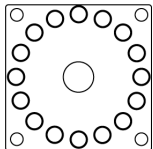
	Part Number	Description	Unit	Note
	8351-BRCK-00-ST	DMI Bracket 100 mm x 100 mm	PC	

Somfy Sunea RTS CMO Universal Bracket

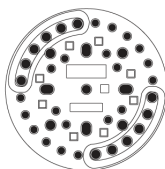
	Part Number	Description	Unit	Note
	8346-BRCK-00-ST		PC	

Connecting Sleeve

	Part Number	Description	Unit	Note
	8055-ACCE-00-ST	7 mm Hexagon To 8 mm Square Rod	PC	
	8056-ACCE-00-ST	For 8 mm Square Rod	PC	

Stainless Steel M6 Nut and Bolt For CMO and DMI Motor

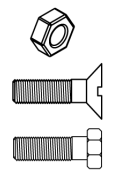
	Part Number	Description	Unit	Note
	8059-ACCE-00-ST	M6-1.0 Hex Nut	PC	
	8054-ACCE-00-ST	M6-1.0 x 25 Hex Cap Screw	PC	
	8058-ACCE-00-ST	M6-1.0 x 25 Flat Phil Screw	PC	

* - Typically ships within 3 days
 N - New item
 ! - Special order item

BRACKETS

Special Bracket for Sidecaps for Simu

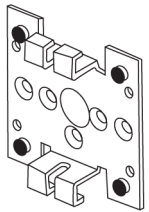
	Part Number	Description	Unit	Note
	8356-BRCK-00-ST	For 500 Series Motors, Dimensions: 3.5" x 3.5"	PC	

Special Bracket for BK- 45 250/S (10") & BK- 45 300/S (12") Sidecaps for Simu

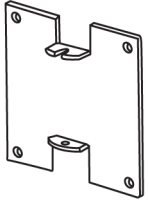
	Part Number	Description	Unit	Note
	8358-BRCK-00-ST	For 500 Series Motors, Dimensions: 4.0" x 4.0"	PC	

U - Bracket

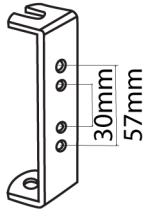
	Part Number	Description	Unit	Note
	8362-BRCK-00-ST	For 600 Series Motors	PC	
	8352-BRCK-00-ST (8362 SHOWN)	For 500 Series Motors, With Holes 30 mm Apart	PC	

Special Bracket For BK- 45 250/S (10") & BK- 45 300/S (12") Sidecaps for Simu

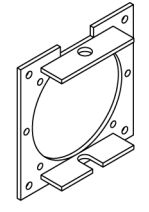
	Part Number	Description	Unit	Note
	8364-BRCK-00-ST	For 600 Series Motors Dimensions: 4" x 4"	PC	

Idler End Cap, Heavy Duty and Support Bracket for T-8 Motors

	Part Number	Description	Unit	Note
	8325-BRCK-00-ST	Support Bracket For Idler End Cap	PC	
	8366-BRCK-00-ST	T8S DMI Operator Bracket	PC	N

* - Typically ships within 3 days
 N - New item
 ! - Special order item